

POWER RELAY

1 POLE - 6A Slim Type (Medium Load Control)

FTR-LY Series

■ FEATURES

- Slim 15.0mm (h) x 5.0 mm (w) x 28.0mm (l)
 - 1 form C and right angle type available
 - Mounting space: 140mm², weight: 5.0g
 - High insulation in small package
Insulation distance (between coil and contacts): 8mm (creepage/clearance)
Dielectric strength: 4,000 VAC
Surge strength: 6,000V
 - Plastic sealed type RTIII
 - UL, CSA, VDE, SEMKO, FIMKO, DEMKO, NEMKO compliance
 - Socket type available
 - RoHS compliant
- Please see page 7 for more information

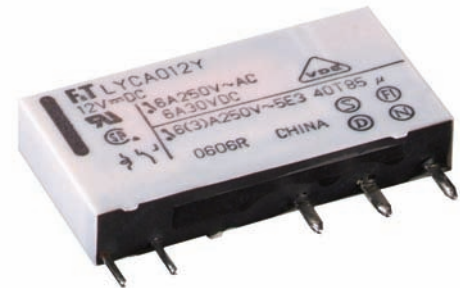

■ PARTNUMBER INFORMATION

[Example] $\frac{\text{FTR-LY}}{\text{(a)}}$ $\frac{\text{A}}{\text{(b)}}$ $\frac{\text{A}}{\text{(c)}}$ $\frac{\text{005}}{\text{(d)}}$ $\frac{\text{Y}}{\text{(e)}}$ - $\frac{\text{SK}}{\text{(f)}}$

(a)	Relay type	FTR-LY : FTR-LY-Series
(b)	Contact configuration	A : 1 form A C : 1 form C P : 1 form A (right angle type) R : 1 form C (right angle type)
(c)	Coil type	A : Standard type (170mW)
(d)	Coil rated voltage	005 : 5.....60 VDC Coil rating table at page 3
(e)	Contact material	E : AgNi Y : AgSnO ₂ V : AgSnO ₂ + Au (0.3μm)
(f)	Special type	Nil : PCB mounting type SK : Socket mounting type (only contact configuration A and C)

Actual marking does not carry the type name : "FTR" and "SK"
E.g.: Ordering code: FTR-LYAA005Y-SK Actual marking: LYAA005Y

FTR-LY SERIES

■ SPECIFICATION

Item	LY (C,R) A () (Y,E,V)		LY (A,P) A () (Y,E,V)	
Contact Data	Configuration		1 form C (SPDT)	
	Construction		Single	
	Material		Y: AgSnO ₂ / E: AgNi / V: AgSnO ₂ + Au 0.3μm	
	Resistance (initial)		Y, E: Max. 100 mΩ at 6 VDC, 1 A V: Max. 30 mΩ at 6 VDC, 1A	
	Contact rating		6A, 250VAC / 24VDC	
	Max. carrying current		6A	
	Max. switching voltage		250VAC	
	Max. switching power		1,500VA / 144W	
	Min. switching load *		Y, E: 100 mA 5 VDC V: 10mA 5 VDC	
Life	Mechanical		Min. 10 x 10 ⁶ operations	
	Electrical		Min. 50 x 10 ³ operations (N.O.) Min. 30 x 10 ³ operations (N.C.) at 6A, 250VAC / 30VDC resistive	
Coil Data	Rated power		170 to 217 mW	
	Operate power		74 to 76 mW	
	Operating temperature range		-40 °C to +85 °C (no frost)	
Timing Data	Operate (at nominal voltage)		Max. 8ms (no diode, without bounce)	
	Release (at nominal voltage)		Max. 4ms (no diode, without bounce)	
Insulation	Resistance (initial)		Min. 1,000MΩ at 500VDC	
	Dielectric strength	Open contacts	1,000VAC (50/60Hz) 1min., 10mA detection current	
		Contacts to coil	4,000VAC (50/60Hz) 1min., 10mA detection current	
	Surge strength	Coil to contacts	6,000V / 1.2 x 50μs standard wave	
	Clearance		8 mm	
	Creepage		8 mm	
	EN61810-1, VDE0435	Voltage	250V	
		Pollution degree	3	
		Material group	III a	
	Category	C / 250V		
Other	Vibration resistance	Misoperation	10 to 55Hz double amplitude 1.0mm	
		Endurance	10 to 55Hz double amplitude 1.5mm	
	Shock	Misoperation	Min. 50m/s ² (11 ± 1ms)	Min. 100m/s ² (11 ± 1ms)
		Endurance	Min. 1,000m/s ² (6 ± 1ms)	
	Weight		Approximately 5 g	
	Sealing		Plastic sealed RTIII	

* Minimum switching loads mentioned above are reference values. Please perform the confirmation test with actual load before production since reference values may vary according to switching frequencies, environmental conditions and expected reliability levels.

■ COIL RATING

Coil Code	Rated Coil Voltage (VDC)	Coil Resistance +/- 10% (Ohm)	Must Operate Voltage (VDC) *	Must Release-Voltage (VDC) *	Max. Coil Voltage (VDC)	Rated Power (mW)
005	5	147	3.3	0.25	11.5	170
006	6	211	4	0.3	13.8	
009	9	476	5.9	0.45	20.7	
012	12	847	7.9	0.6	27.6	
018	18	1,910	11.9	0.9	41.4	
024	24	3,390	15.9	1.2	55.2	
048	48	10,600	31.7	2.4	110.4	217
060	60	20,570	39.6	3	138	175

Note: All values in the table are valid for 20°C and zero contact current.

* Specified operate values are valid for pulse wave voltage.

■ SAFETY STANDARDS

Type	Compliance	Contact rating
UL	UL 508	Flammability: UL 94-V0 (plastics)
	E63614	5A, 277 VAC (resistive) 5A, 30 VDC (resistive)
CSA	C22.2 No. 14 LR 40304	1/10 HP, 277VAC /125VAC Pilot duty: D300, C300, R300, B300
VDE 40006591	EN 61810-1 (VDE 0435-Part 201) 2004-07	250VAC; 6A / 30VDC; 6A : - 10K ops. FTR-LY(A;P)A...(E;Y;V) -40 °C to +85 °C - 5K ops. FTR-LY(C;R)A...(E;Y;V) -40 °C to +85 °C
	EN 60730-1 (VDE 0631-Part 1)	250VAC; 6(1,5)A, 30K ops. : FTR-LY(A;P)A...(Y;V) +85 °C 250VAC; 3(1,5)A, 100K ops. : FTR-LY(A;P)A...(Y;V) +85 °C
	EN 61984 (VDE 0627) EN 60335-1 (VDE 0700-Part 1)	-

CHARACTERISTIC DATA

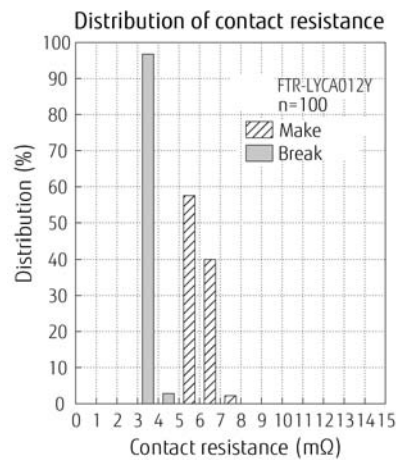
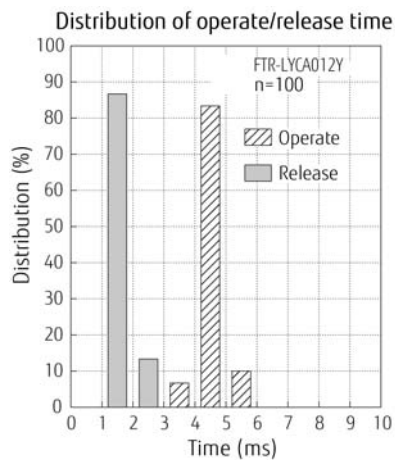
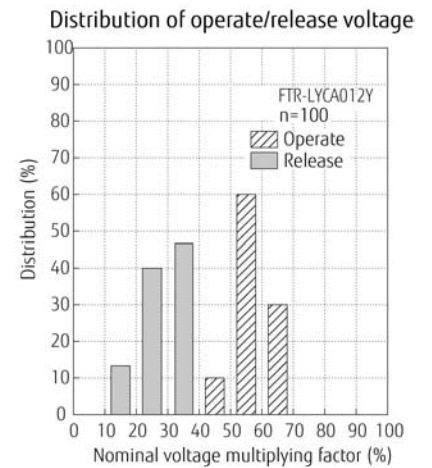
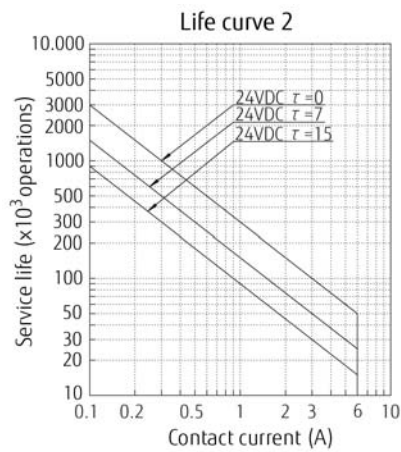
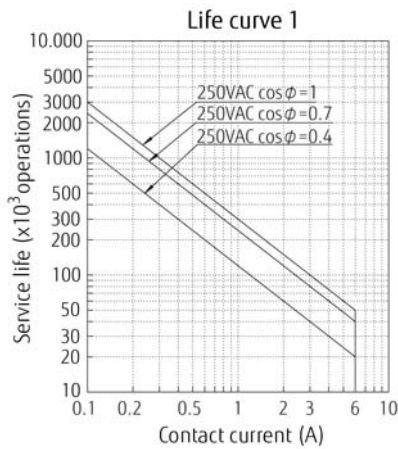
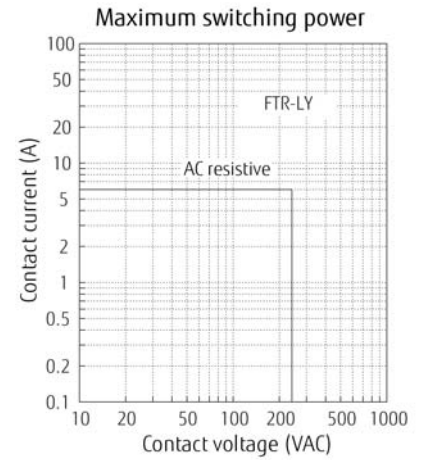
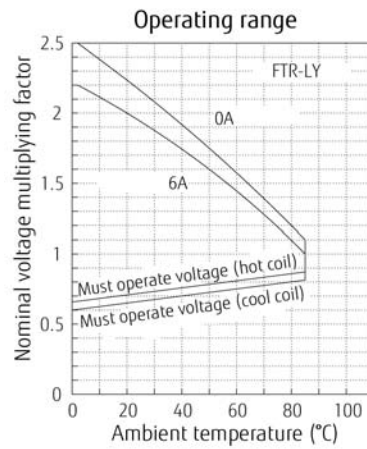
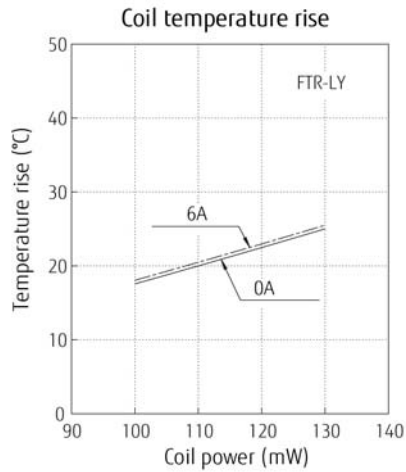

■ DIMENSIONS

Straight terminal type

● Dimensions

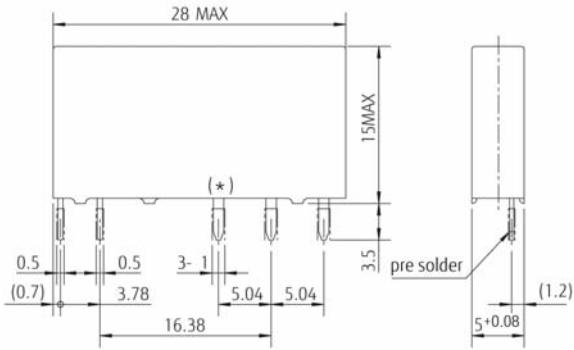

● Schematics



● PC board mounting hole layout (BOTTOM VIEW)

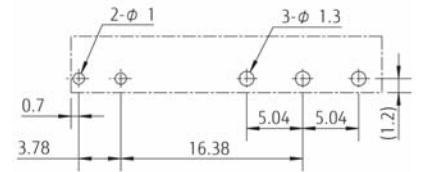

Right angle type

● Dimensions

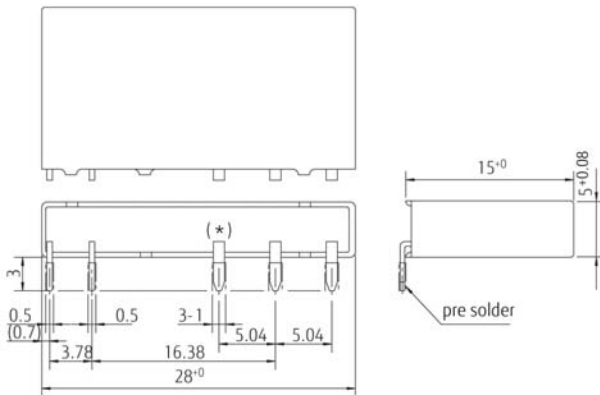

● Schematics

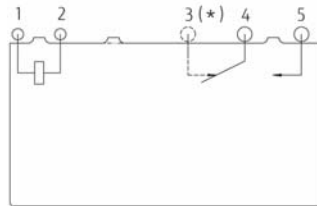

● PC board mounting hole layout (BOTTOM VIEW)

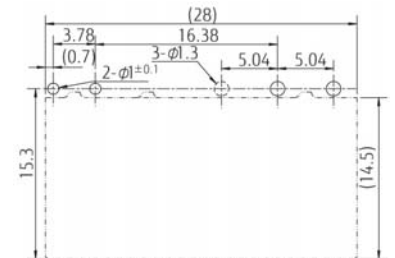

Unit: mm

* This terminal is not applicable for 1 form A type.

FTR-LY SERIES

Socket type

- Dimensions

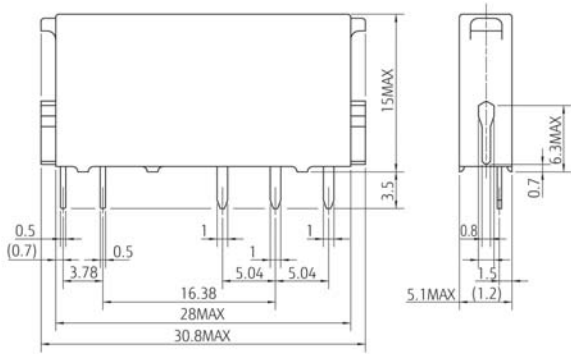

- Schematics



- PC board mounting hole layout (BOTTOM VIEW)

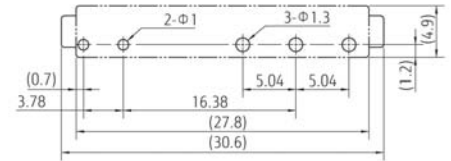

JM-6N

- Dimensions

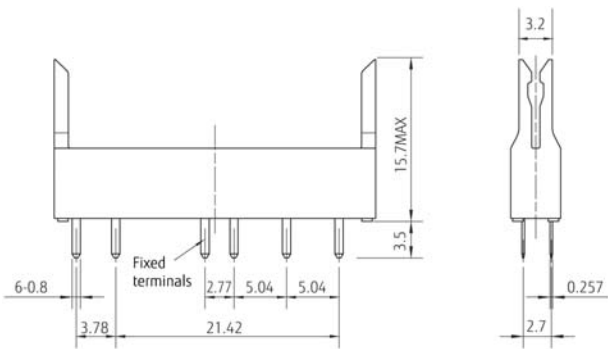

- Schematics

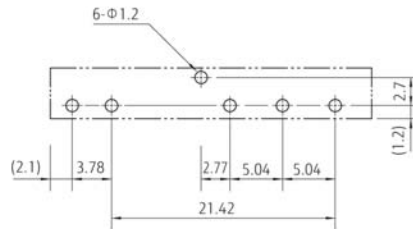

RoHS Compliance and Lead Free Information

1. General Information

- All signal and power relays produced by Fujitsu Components are compliant with RoHS directive 2002/95/EC including amendments.
- Cadmium as used in electrical contacts is exempted from the RoHS directives on October 21st, 2005. (Amendment to Directive 2002/95/EC)
- All of our signal and power relays are lead-free. Please refer to Lead-Free Status Info for older date codes at: <http://www.fujitsu.com/us/downloads/MICRO/fcai/relays/lead-free-letter.pdf>
- Lead free solder plating on relay terminals is Sn-3.0Ag-0.5Cu, unless otherwise specified. This material has been verified to be compatible with PbSn assembly process.

2. Recommended Lead Free Solder Profile

- **Recommended solder Sn-3.0Ag-0.5Cu.**

Flow Solder condition:

Pre-heating: maximum 120°C
Soldering: dip within 5 sec. at
260°C solder bath

Solder by Soldering Iron:

Soldering Iron
Temperature: maximum 360°C
Duration: maximum 3 sec.

We highly recommend that you confirm your actual solder conditions

3. Moisture Sensitivity

- Moisture Sensitivity Level standard is not applicable to electromechanical relays, unless otherwise indicated.

4. Tin Whiskers

- Dipped SnAgCu solder is known as presenting a low risk to tin whisker development. No considerable length whisker was found by our in house test.

Fujitsu Components International Headquarter Offices

Japan

Fujitsu Component Limited
Gotanda-Chuo Building
3-5, Higashigotanda 2-chome, Shinagawa-ku
Tokyo 141, Japan
Tel: (81-3) 5449-7010
Fax: (81-3) 5449-2626
Email: promothq@ft.ed.fujitsu.com
Web: www.fcl.fujitsu.com

North and South America

Fujitsu Components America, Inc.
250 E. Caribbean Drive
Sunnyvale, CA 94089 U.S.A.
Tel: (1-408) 745-4900
Fax: (1-408) 745-4970
Email: components@us.fujitsu.com
Web: <http://us.fujitsu.com/components>

Europe

Fujitsu Components Europe B.V.
Diamantlaan 25
2132 WV Hoofddorp
Netherlands
Tel: (31-23) 5560910
Fax: (31-23) 5560950
Email: info@fceu.fujitsu.com
Web: emea.fujitsu.com/components/

Asia Pacific

Fujitsu Components Asia Ltd.
102E Pasir Panjang Road
#01-01 Citilink Warehouse Complex
Singapore 118529
Tel: (65) 6375-8560
Fax: (65) 6273-3021
Email: fcal@fcal.fujitsu.com
Web: <http://www.fujitsu.com/sg/services/micro/components/>

©2011 Fujitsu Components Europe B.V. All rights reserved. All trademarks or registered trademarks are the property of their respective owners.

The contents, data and information in this datasheet are provided by Fujitsu Component Ltd. as a service only to its user and only for general information purposes.

The use of the contents, data and information provided in this datasheet is at the users' own risk.

Fujitsu has assembled this datasheet with care and will endeavor to keep the contents, data and information correct, accurate, comprehensive, complete and up to date.

Fujitsu Components Europe B.V. and affiliated companies do however not accept any responsibility or liability on their behalf, nor on behalf of its employees, for any loss or damage, direct, indirect or consequential, with respect to this datasheet, its contents, data, and information and related graphics and the correctness, reliability, accuracy, comprehensiveness, usefulness, availability and completeness thereof.

Nor do Fujitsu Components Europe B.V. and affiliated companies accept on their behalf, nor on behalf of its employees, any responsibility or liability for any representation or warrant of any kind, express or implied, including warranties of any kind for merchantability or fitness for particular use, with respect to these datasheets, its contents, data, information and related graphics and the correctness, reliability, accuracy, comprehensiveness, usefulness, availability and completeness thereof. Rev. June 08, 2011